

APPLICATION NOTE 187

Grounding, shielding and filtering - Installation of the drive system in the machine

Summary

This Application Note describes how to install a drive system in your machine. It contains advice on creating a setup that is working robustly in terms of encoder signal quality, providing the basis for reliable motor control. The focus is on proper grounding and shielding. The underlying principles apply no matter the size of your machine or your device. Such a clean installation is also the precondition for passing any EMC certification.

Applies To

FAULHABER Motion Controllers (MC V3.0)

and can be applied to any other motor driver or controlled motor.

Description

A good grounding concept is one of the most important parts of the machine design. It is the basis for a disturbance-free operation of the machine. All components of the machine need a low-resistance ground connection for both low and high frequencies (RF). Unfortunately, the high frequencies are often not in focus when designing a system. In addition to the required PE connection, the grounding must be setup using low-impedance connections for RF, too.

Especially when designing a system which has to pass an EMC certification, missing out one relevant measure would cause major performance issues. Even when no EMC certification is required, proper grounding and shielding will still pay off in terms of a reliable and robust setup.

In principle every drive system generates low and high frequency conducted and radiated disturbances. EMC measures reduce these disturbances a lot, partially transferring them into currents towards ground. The ground currents need to be able to flow back to the Motion Controller in order not to disturb other components of the system.

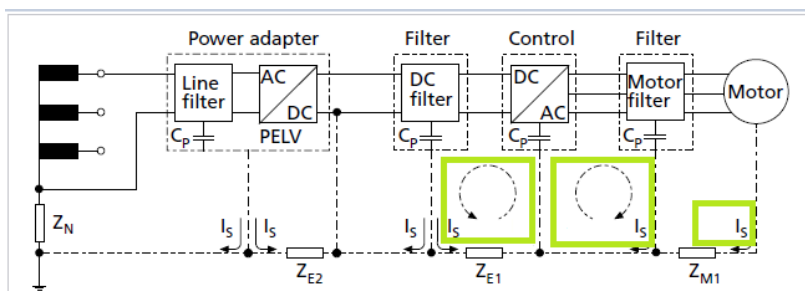

Figure 1: Ground currents – flowing back to the drive controller

Grounding and Shielding

The following describes what to focus on when designing and installing a system:

1) Mounting plate

A conductive metal mounting plate must be set up. It is recommended to be the star point for the high frequency grounding. Ideally Motion Controllers, any additional filters and the cable shieldings are directly mounted on and connected to that metal mounting plate.

2) PE rail

Earthing is a measure of electrical safety. A PE rail should be the star point to connect all yellow-green PE cables of the system to.



PE rails and PE cables do neither replace high frequency grounding nor any shielding. In this Application Note protective **earthing** (PE) always refers to electrical safety and **grounding** (functional earthing, FE) to the EMC measure of providing a low-impedance ground connection for RF.

If the PE rail is mounted besides the mounting plate a RF connection to the mounting plate must be setup. This can be realized using a RF strap.



Figure 2: RF strap connection from mounting plate to PE rail [1]

3) Grounding of the machine chassis

When using a metal machine chassis, which is recommended to reduce radiated emission, connect it to the mounting plate with a RF strap and to the PE rail using a PE cable.

4) Grounding of the motor housing

The motor has to be connected to a conductive metal machine part. This is usually realized simply by flange-mounting the motor using screws. The machine part that the motor is mounted to, must be connected to the ground system of the setup using a RF strap. The grounding avoids radiated emission from the motor providing a path for ground currents to flow back to the Motion Controller.

5) Grounding of the Motion Controller

There are different possibilities of how to mount the Motion Controller. Despite the specific setup always make sure to have a grounded metal machine part connected to a metal part of the Motion Controller. This will be the path required for ground currents to flow back to the controller (see figure 1).

- A top-hat rail can be used for the setup. The top-hat rail must be properly connected to the mounting plate. The two screw holes in the backplane of the Motion Controller can be used to attach a clip to. Usually no painting has to be removed, since a metal connection is provided via these screw holes (see figure 3).

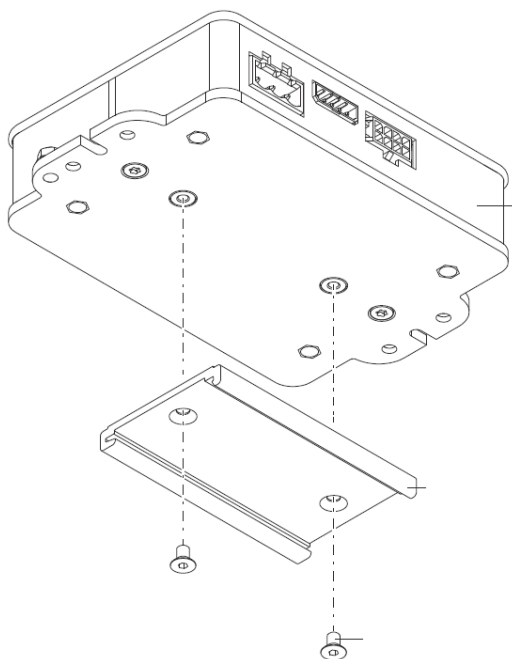

Figure 3: Top-hat rail clip mounting

- Alternatively, if a proper ground connection cannot be setup via the backplane of the Motion Controller, it has to be established connecting a RF strap to the screw connection of the Motion Controller (see figure 4). The other end of the RF strap must be connected to the mounting plate, of course.

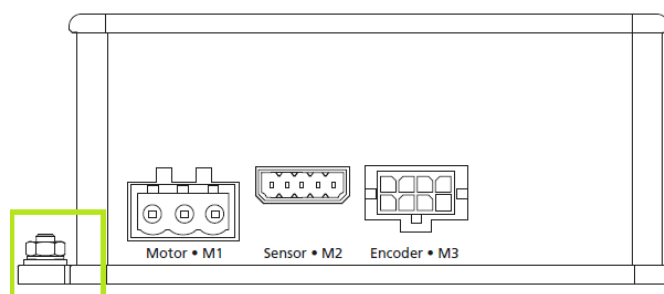

Figure 4: Screw connection for a RF strap

6) Shielding of the cables

Cables with motor phases (connected to M1 – figure 4) require shielding to decrease emissions.

Cables providing power supply for the Motion Controller (connected to U_{mot} and U_p) also benefit from shielding by decreasing the emission.

Cables with encoder or hall signals (connected to M3 or M2 – figure 4) require shielding to increase immunity towards disturbances.

When EMC certification of the machine is a requirement consider shielding of all cables connected to the Motion Controller even the short ones – below 0.5 m cable length.



Shielding will only be sufficient when the shield is properly grounded on **both** sides of the cable. Grounding the shield on both sides requires to have a ground setup with no relevant potential differences.

And make sure to always use **shield clamps** to connect the shield directly to the mounting plate or a top-hat rail.

The best results are achieved when the shield does not end at the shield clamp but also covers the rest of the cable all the way up to the motor, respectively to the controller.

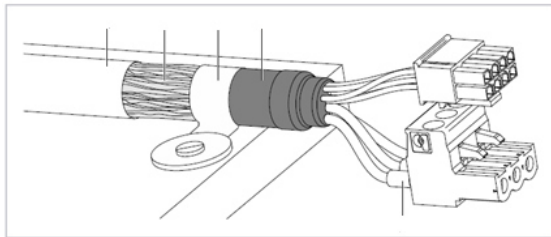

Figure 5: Usage of shield clamps for grounding cable shields



Do not connect the shield via a cable to the grounded machine parts. Such a cable is called a pig-tail and does not provide a good RF connection.

Only one incorrectly or not shielded cable can disturb the performance of the machine.

- Motor phases must never be routed within the same shield as encoder or hall signals. Using separate cables is preferred. Separate shields are the minimum requirement.
- If there are multiple shields in one cable every shield must be separately connected to the ground potential using shield clamps.

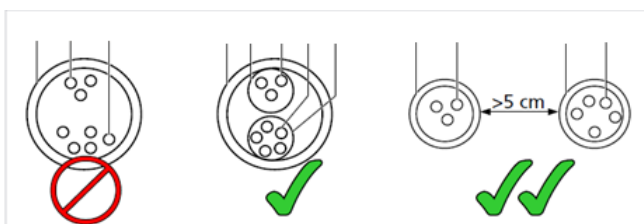

Figure 6: Shielding by function

The shield

- Always use braided copper shields for the motor phases and the power supply lines.
- It is recommended to use braided copper shields for encoder and hall signals too, due to their usually better shielding effect compared to foil shields.

7) Cables and routing

The Cable



For line driver encoders always use twisted pair cables.

- The length of the cables should fit the setup perfectly. Cables being longer than required have to be avoided in order not to pick up any disturbances.

The routing

- If possible, use a metal cable duct for routing
- Separate the cables by function:
Especially motor phases require clearance from encoder and hall signal lines, ideally separated by metal plates.
- Lay the cables near the corners of the metal cable duct to benefit of the shielding of the metal duct

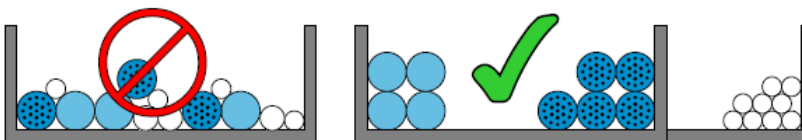

Figure 7: Separation of cables by function

- Lay all cables and especially power supply lines and motor phases as close as possible to the ground reference – here the mounting plate, when outside of the metal duct.



Figure 8: Routing close to the ground plane [1]

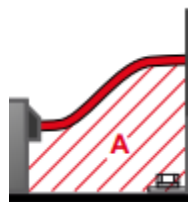

Figure 9: Poor routing away from the ground plane increases radiated emission [1]

- Avoid any crossing of motor phases or power supply lines with encoder or hall signals. If it cannot be avoided cross at a 90° angle, only.

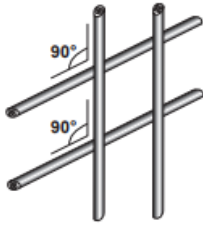

Figure 10: Crossing cables having different functions

- When connecting multiple devices to one power supply, every device requires its own supply line and a GND line directly connected to the power supply, meaning the power supply will be a star point.
- Always route the respective supply and return cable together.

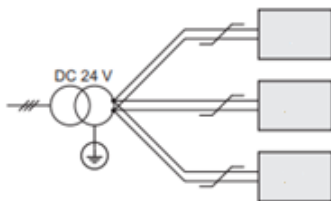

Figure 11: Power supply as start point

- Do **not** connect the supply GND line of the Motion Controller with functional earth.
- Always use EMC cable glands if a plug connection must be used. They provide a connection of the shield to the grounded machine chassis. If possible, avoid any cable glands or cable extensions at all.



Figure 12: EMC cable gland

8) Example of a good EMC setup

This is a setup in a small metal case with a cover.

- A mounting plate (1) is in place and top-hat rails (2) are used for component installation.
- All cables which are connected to the Motion Controller are shielded: these are the supply lines (3), the encoder (4), the digital hall sensors (5) and the motor phases (6).
- The shields are attached to the top-hat rails using shield clamps (7).
- EMC cable glands (8) are used to pass the cables through the chassis.
- A RF strap (9) is used to connect the cover to the chassis



Figure 13: Setup in a metal case

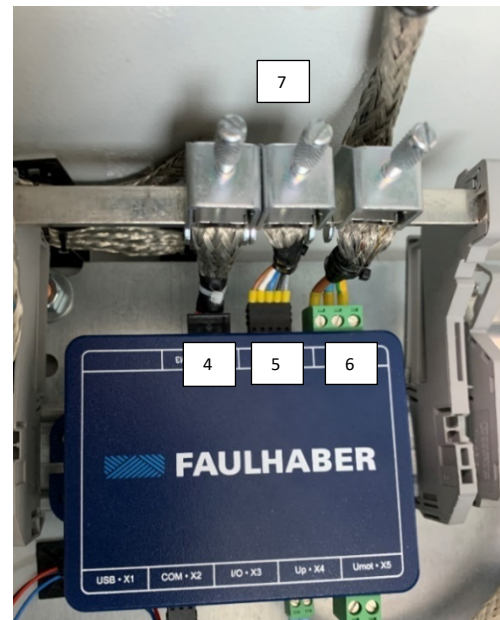

Figure 14: Usage of shield clamps

Even this good setup can still be improved by connecting the supply line's (3) shield to ground on both sides of the cable, close to its respective end. And by routing the supply line much closer to the mounting plate. Both measures would further decrease radiated emissions.

Filtering

Filtering of motor phases

If grounding and shielding is not sufficient to provide a good encoder signal quality, consider filtering the motor phases using ferrites to reduce **radiated emission**. This might especially be necessary when a cable length above 5 m is used.



The FAULHABER Filter EFC 5008 would be a good choice for this purpose.

EFC 5008
6501.00351

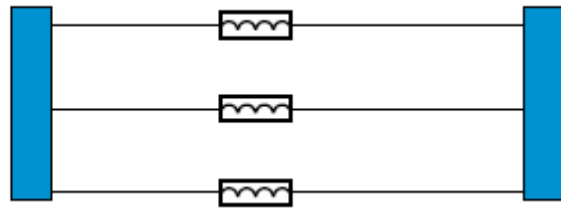

Figure 15: EFC filter

- Install the filter as close as possible to the Motion Controller on the same metal surface.

Filtering of supply lines of the Motion Controllers

When an EMC certification of the machine is required an additional filter for the supply line has to be considered. Its purpose is to dampen **conducted disturbances** on the supply lines of the Motion Controllers (see figure 14, number 3 to locate the cable with the supply line). The power supply itself usually already provides some damping, but it is likely not sufficient.

The FAULHABER Filter EFS can be used for this purpose.

EFS 5005
6501.00350
EFS 3004
6501.00367

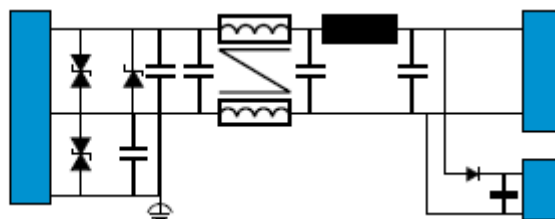

Figure 16: EFS filter

- It might be sufficient to have only one EFS filter per power supply. It can be connected to multiple Motion Controllers when the rated current of the filter is adequate for the application.
- If such an EFS filter is installed make sure that the power supply lines in front of the filter do not run in parallel or cross with other cables, to keep these already filtered supply lines clean.

Selection of the encoder

- Use a **line driver** version if
 - an absolute¹ encoder with a cable length > **30 cm** will be used
 - an incremental² encoder with a cable length > **0.5..1 m** will be used
- Absolute encoders with line drivers require **termination** to avoid signal reflection. If the controller does not have a termination included (option 6419), a 120 ohm resistor between Data and /Data on the controller side is required.
- Take extra care, when designing a system with absolute encoders to make sure the signals are not disturbed by high frequency EMI.
- Absolute encoders with line drivers will be preferred over hall-feedback (analog or digital hall) when a cable length over 2 m has to be realized. Over 5 m cable length a hall-feedback system is likely to be heavily disturbed.
- An Absolute encoder reduces the number of required cables by one compared to a setup with incremental encoder + hall signals.

Selection of the power supply



A **24V system** is more robust than a 48V system since less disturbances are emitted from the motor phases when supplied with a lower voltage.

- Consider using a 24V motor type instead of a 48V motor type. But keep in mind, currents on the 24V system will of course be twice the ones of the 48V system.

- 1 Setups with line driver absolute encoders of up to 5 m cable length were successfully tested. Setups with longer cables have to be qualified, with 15 m being the physical limit.
- 2 BLDC motors using incremental encoders need additional digital hall signals for commutation. Digital halls in a single-ended version as provided by FAULHABER were successfully tested up to 5 m cable length. A line driver incremental encoder was used for this setup.

Additional Resources

For a very detailed description on EMC measures please refer to the EMC chapter of the Technical manual of the Motion Controllers MC5010 / MC5005 at www.faulhaber.com/manuals.

For information on the filters refer to the EFC and EFS datasheets at www.faulhaber.com in the product category – accessories.

[1] The SEW document <https://download.sew-eurodrive.com/download/pdf/19469608.pdf> was used as a resource for this Application Note.

Rechtliche Hinweise

Urheberrechte. Alle Rechte vorbehalten. Ohne vorherige ausdrückliche schriftliche Zustimmung der Dr. Fritz Faulhaber & Co. KG darf diese Application Note oder Teile dieser unabhängig von dem Zweck insbesondere nicht vervielfältigt, reproduziert, gespeichert (z.B. in einem Informationssystem) oder be- oder verarbeitet werden.

Gewerbliche Schutzrechte. Mit der Veröffentlichung, Übergabe/Übersendung oder sonstigen Zur-Verfügung-Stellung dieser Application Note werden weder ausdrücklich noch konkludent Rechte an gewerblichen Schutzrechten, übertragen noch Nutzungsrechte oder sonstige Rechte an diesen eingeräumt. Dies gilt insbesondere für gewerbliche Schutzrechte, die mittelbar oder unmittelbar den beschriebenen Anwendungen und/oder Funktionen dieser Application Note zugrunde liegen oder mit diesen in Zusammenhang stehen.

Kein Vertragsbestandteil; Unverbindlichkeit der Application Note. Die Application Note ist nicht Vertragsbestandteil von Verträgen, die die Dr. Fritz Faulhaber GmbH & Co. KG abschließt, und der Inhalt der Application Note stellt auch keine Beschaffenheitsangabe für Vertragsprodukte dar, soweit in den jeweiligen Verträgen nicht ausdrücklich etwas anderes vereinbart ist. Die Application Note beschreibt unverbindlich ein mögliches Anwendungsbeispiel. Die Dr. Fritz Faulhaber GmbH & Co. KG übernimmt insbesondere keine Gewährleistung oder Garantie dafür und steht auch insbesondere nicht dafür ein, dass die in der Application Note illustrierten Abläufe und Funktionen stets wie beschrieben aus- und durchgeführt werden können und dass die in der Application Note beschriebenen Abläufe und Funktionen in anderen Zusammenhängen und Umgebungen ohne zusätzliche Tests oder Modifikationen mit demselben Ergebnis umgesetzt werden können. Der Kunde und ein sonstiger Anwender müssen sich jeweils im Einzelfall vor Vertragsabschluss informieren, ob die Abläufe und Funktionen in ihrem Bereich anwendbar und umsetzbar sind.

Keine Haftung. Die Dr. Fritz Faulhaber GmbH & Co. KG weist darauf hin, dass aufgrund der Unverbindlichkeit der Application Note keine Haftung für Schäden übernommen wird, die auf die Application Note und deren Anwendung durch den Kunden oder sonstigen Anwender zurückgehen. Insbesondere können aus dieser Application Note und deren Anwendung keine Ansprüche aufgrund von Verletzungen von Schutzrechten Dritter, aufgrund von Mängeln oder sonstigen Problemen gegenüber der Dr. Fritz Faulhaber GmbH & Co. KG hergeleitet werden.

Änderungen der Application Note. Änderungen der Application Note sind vorbehalten. Die jeweils aktuelle Version dieser Application Note erhalten Sie von Dr. Fritz Faulhaber GmbH & Co. KG unter der Telefonnummer +49 7031 638 688 oder per Mail von mcsupport@faulhaber.de.

Legal notices

Copyrights. All rights reserved. This Application Note and parts thereof may in particular not be copied, reproduced, saved (e.g. in an information system), altered or processed in any way irrespective of the purpose without the express prior written consent of Dr. Fritz Faulhaber & Co. KG.

Industrial property rights. In publishing, handing over/dispatching or otherwise making available this Application Note Dr. Fritz Faulhaber & Co. KG does not expressly or implicitly grant any rights in industrial property rights nor does it transfer rights of use or other rights in such industrial property rights. This applies in particular to industrial property rights on which the applications and/or functions of this Application Note are directly or indirectly based or with which they are connected.

No part of contract; non-binding character of the Application Note. The Application Note is not a constituent part of contracts concluded by Dr. Fritz Faulhaber & Co. KG and the content of the Application Note does not constitute any contractual quality statement for products, unless expressly set out otherwise in the respective contracts. The Application Note is a non-binding description of a possible application. In particular Dr. Fritz Faulhaber & Co. KG does not warrant or guarantee and also makes no representation that the processes and functions illustrated in the Application Note can always be executed and implemented as described and that they can be used in other contexts and environments with the same result without additional tests or modifications. The customer and any user must inform themselves in each case before concluding a contract concerning a product whether the processes and functions are applicable and can be implemented in their scope and environment.

No liability. Owing to the non-binding character of the Application Note Dr. Fritz Faulhaber & Co. KG will not accept any liability for losses arising from its application by customers and other users. In particular, this Application Note and its use cannot give rise to any claims based on infringements of industrial property rights of third parties, due to defects or other problems as against Dr. Fritz Faulhaber GmbH & Co. KG.

Amendments to the Application Note. Dr. Fritz Faulhaber & Co. KG reserves the right to amend Application Notes. The current version of this Application Note may be obtained from Dr. Fritz Faulhaber & Co. KG by calling +49 7031 638 688 or sending an e-mail to mcsupport@faulhaber.de.